

# ELEGANTA TILE – Eaves Flashing

GERARD

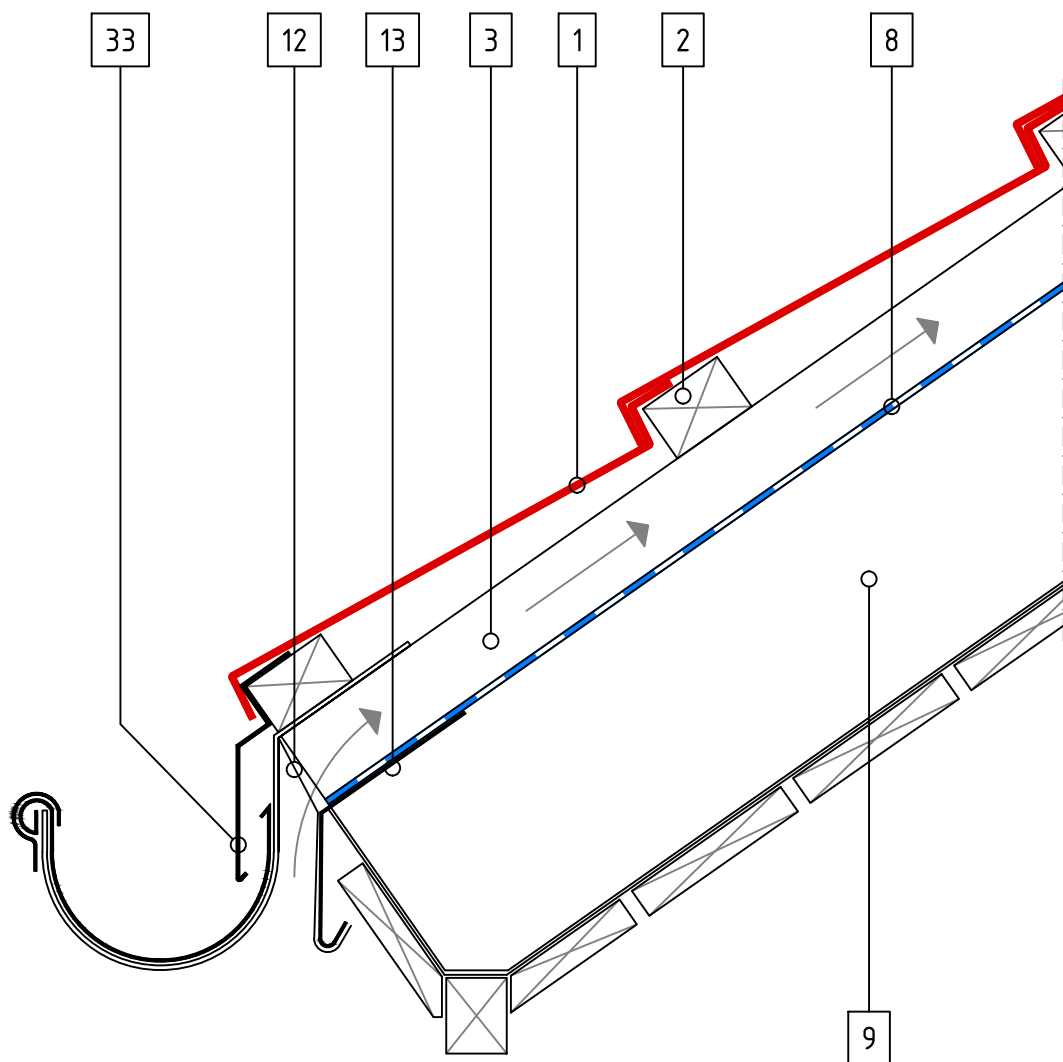

SCALE 1:5

- 1 Tile
- 2 Tile Batten
- 3 Ventilation Space Batten
- 8 Underlay
- 9 Rafter
- 12 Mesh
- 13 Eaves Guard Flashing
- 33 Eaves Flashing 1350

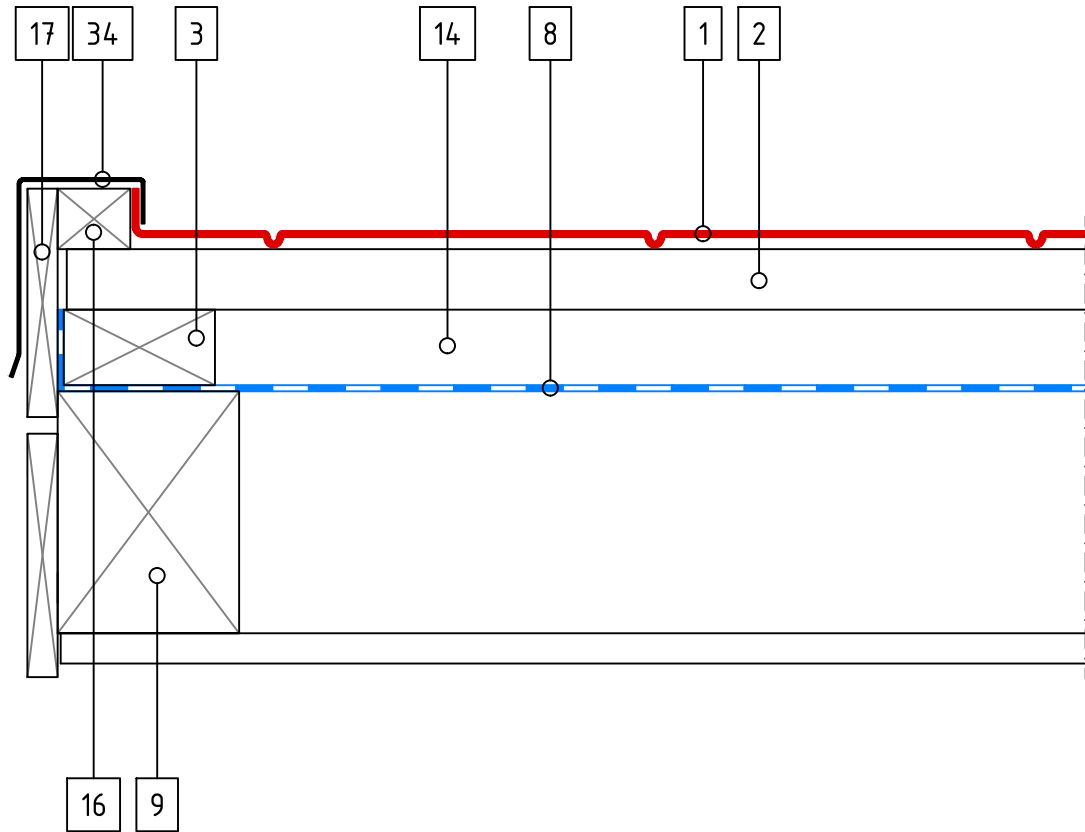

SCALE 1:5

- 1 Tile
- 2 Tile Batten
- 3 Ventilation Space Batten
- 8 Underlay
- 9 Rafter
- 14 Ventilation Space
- 16 Gable Batten
- 17 Barge Board
- 34 Scribed Box Barge

# ELEGANTA TILE – Basic Principle 1

GERARD

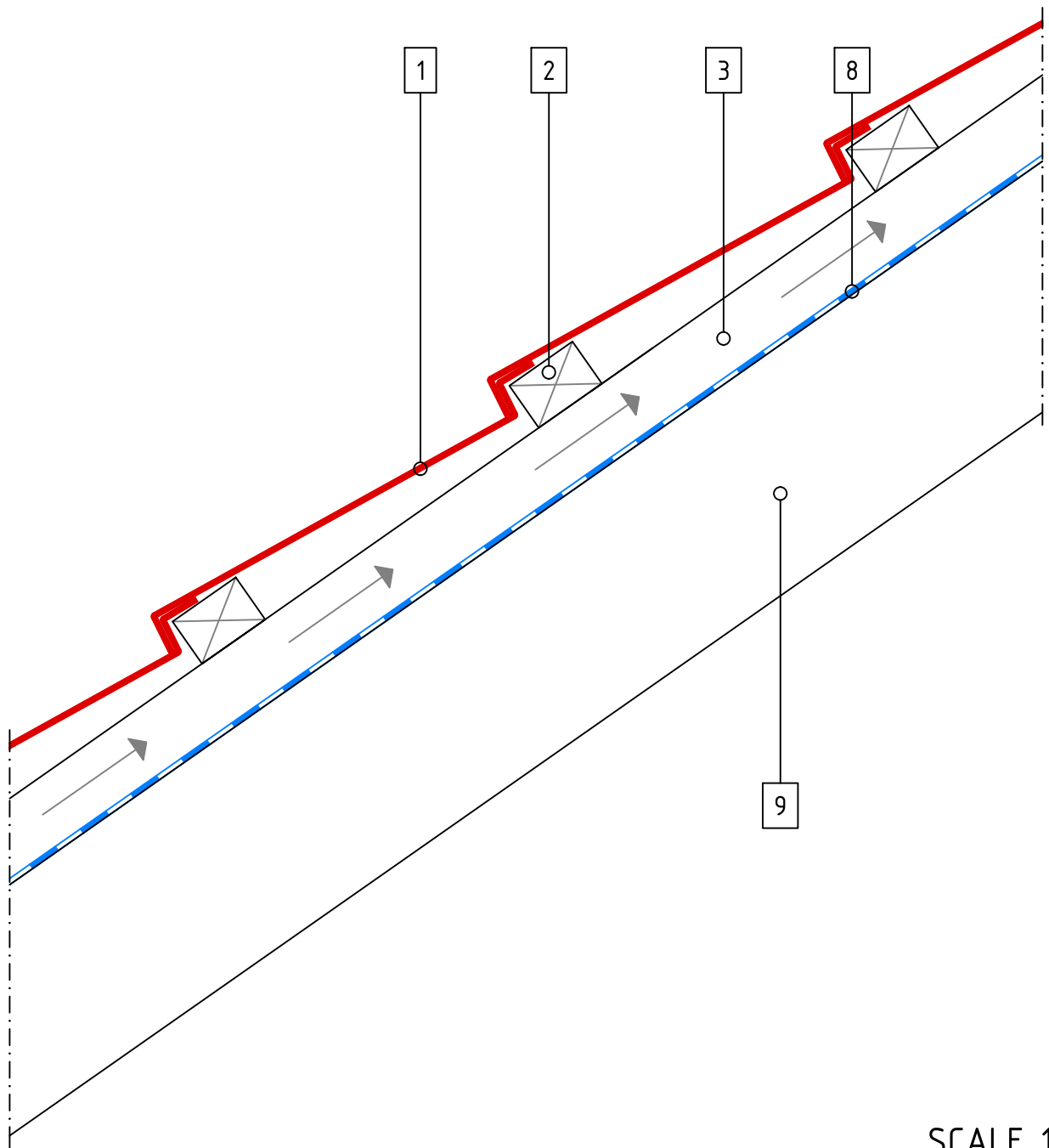

SCALE 1:5

- 1 Tile
- 2 Tile Batten
- 3 Ventilation Space Batten
- 8 Underlay
- 9 Rafter

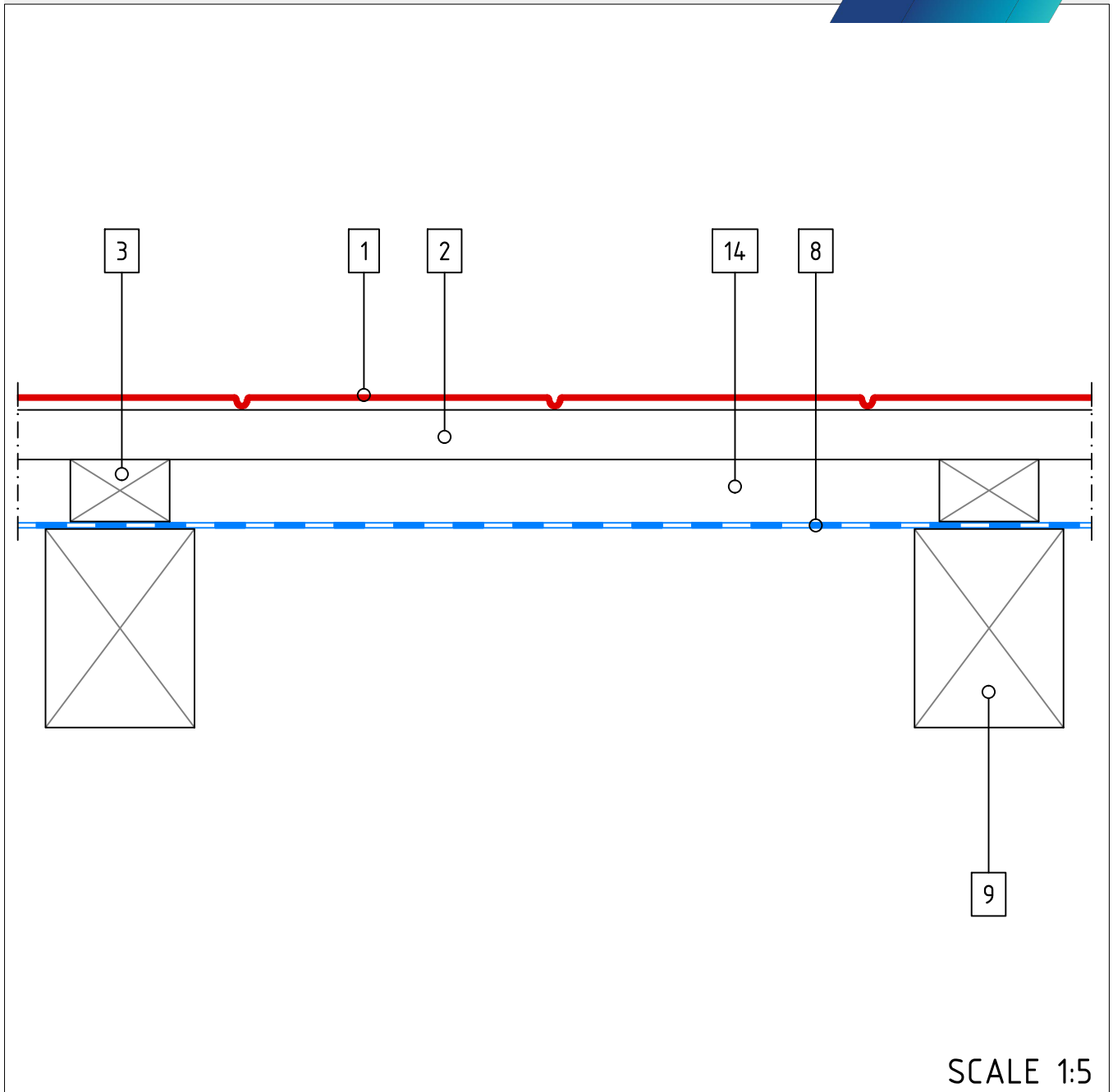

SCALE 1:5

- 1 Tile
- 2 Tile Batten
- 3 Ventilation Space Batten
- 8 Underlay
- 9 Rafter
- 14 Ventilation Space

# ELEGANTA TILE – Ridge 1

GERARD

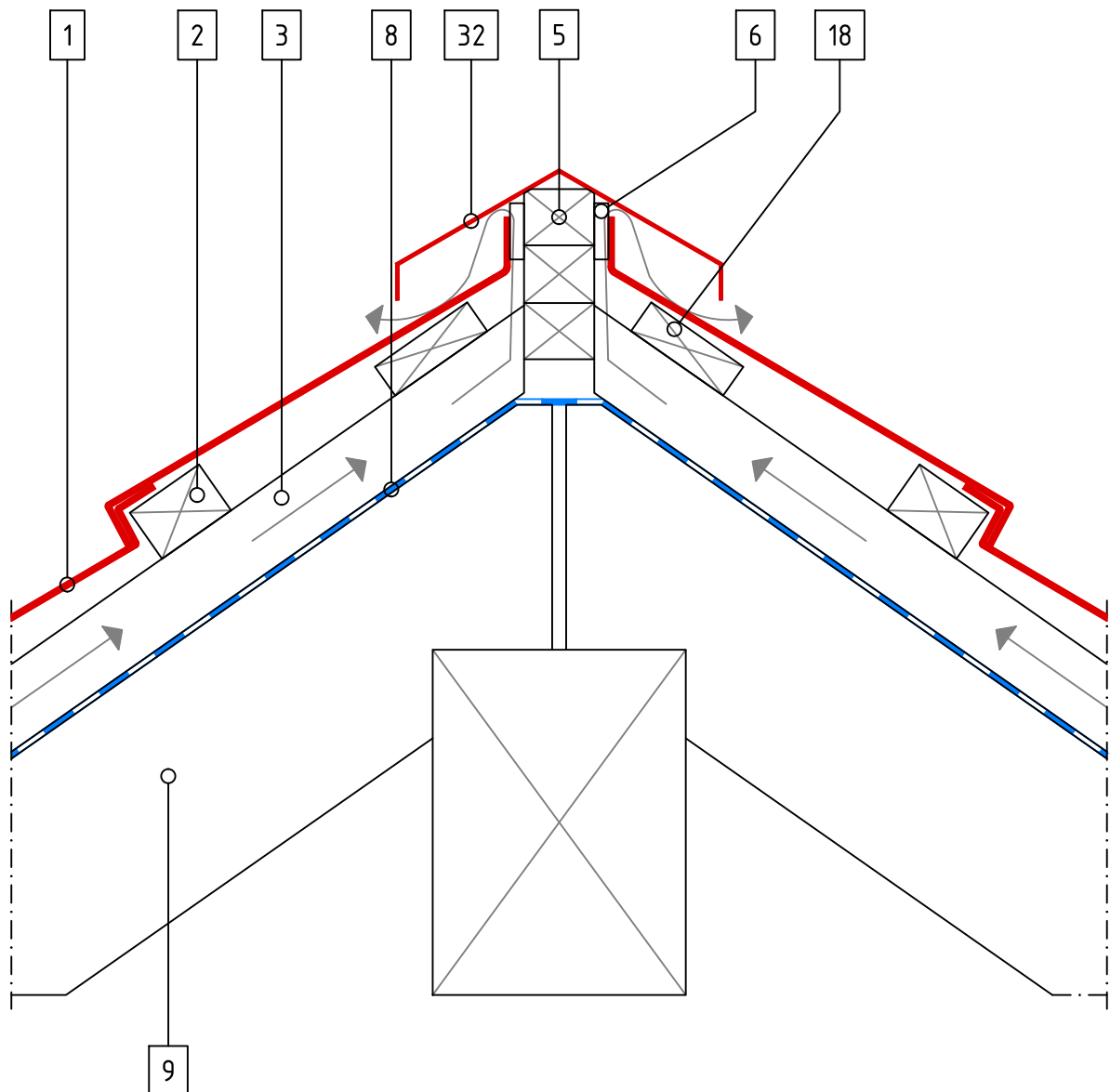

SCALE 1:5

- 1 Tile
- 2 Tile Batten
- 3 Ventilation Space Batten
- 5 Ridge Batten
- 6 Spacer
- 8 Underlay
- 9 Rafter
- 18 Thinner Support Batten
- 32 Ridge Cover 130

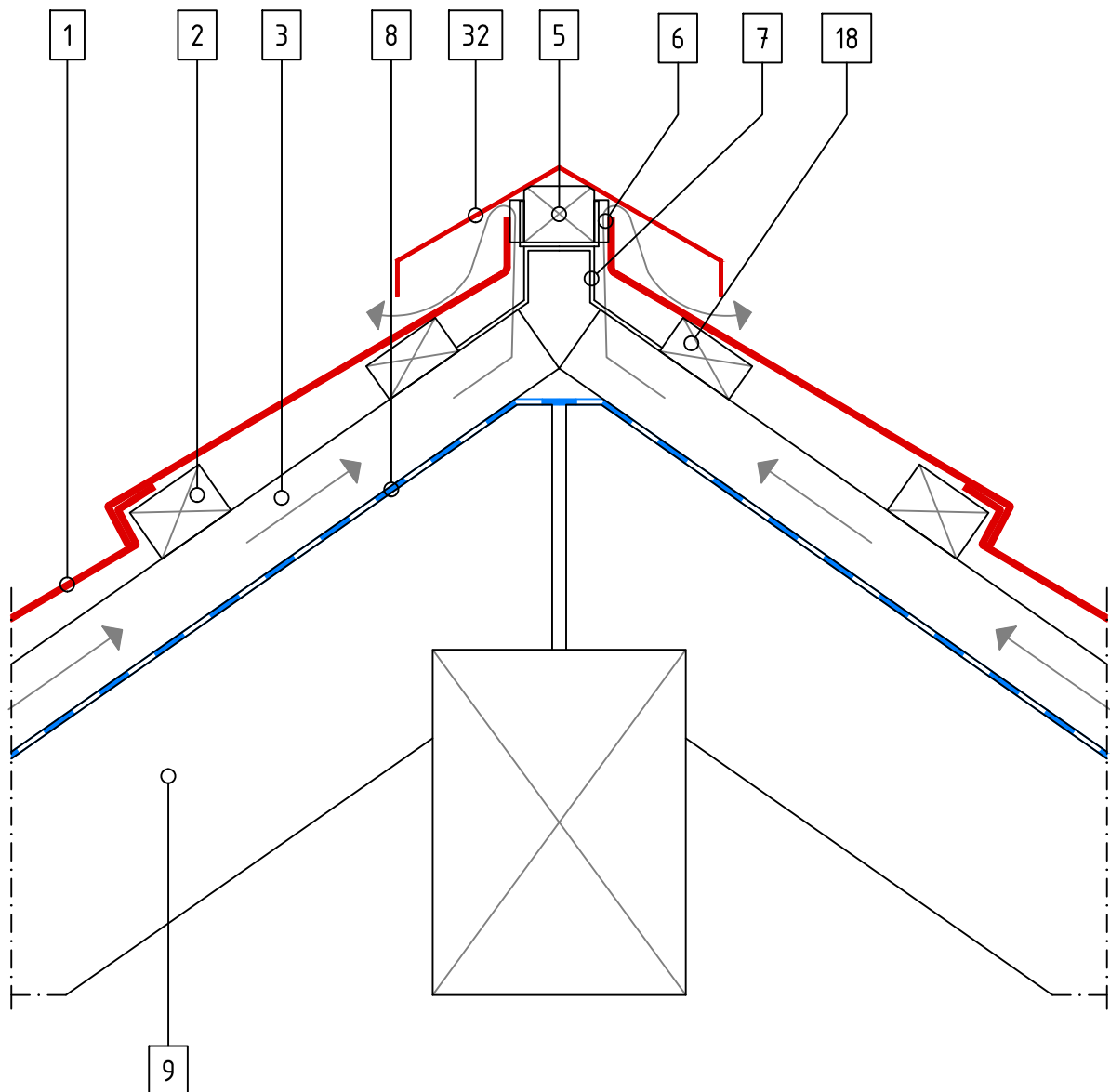

SCALE 1:5

- 1 Tile
- 2 Tile Batten
- 3 Ventilation Space Batten
- 5 Ridge Batten
- 6 Spacer
- 7 Ridge Bracket
- 8 Underlay
- 9 Rafter
- 18 Thinner Support Batten
- 32 Ridge Cover 130

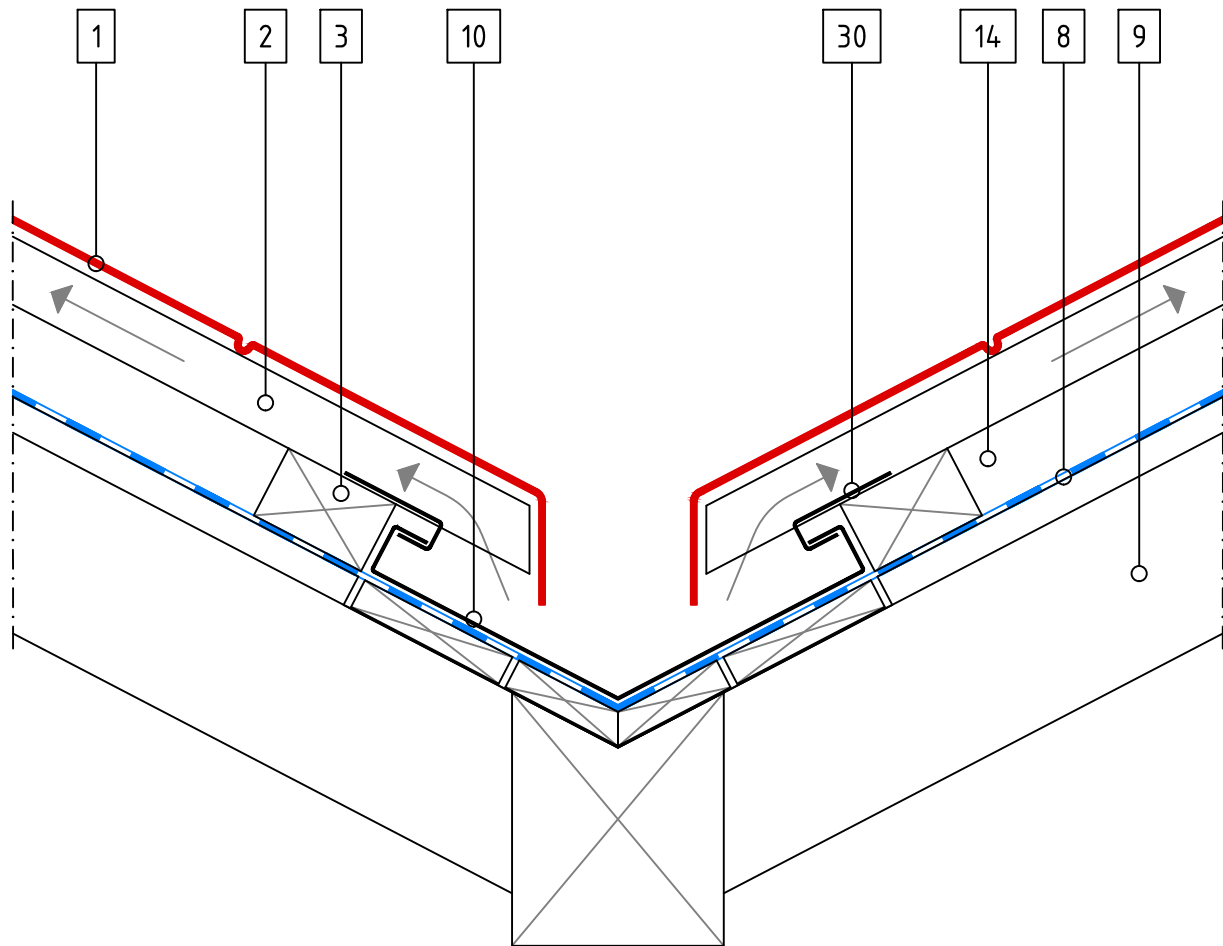

SCALE 1:5

- 1 Tile
- 2 Tile Batten
- 3 Ventilation Space Batten
- 8 Underlay
- 9 Rafter
- 10 Valley
- 14 Ventilation Space
- 30 Clip

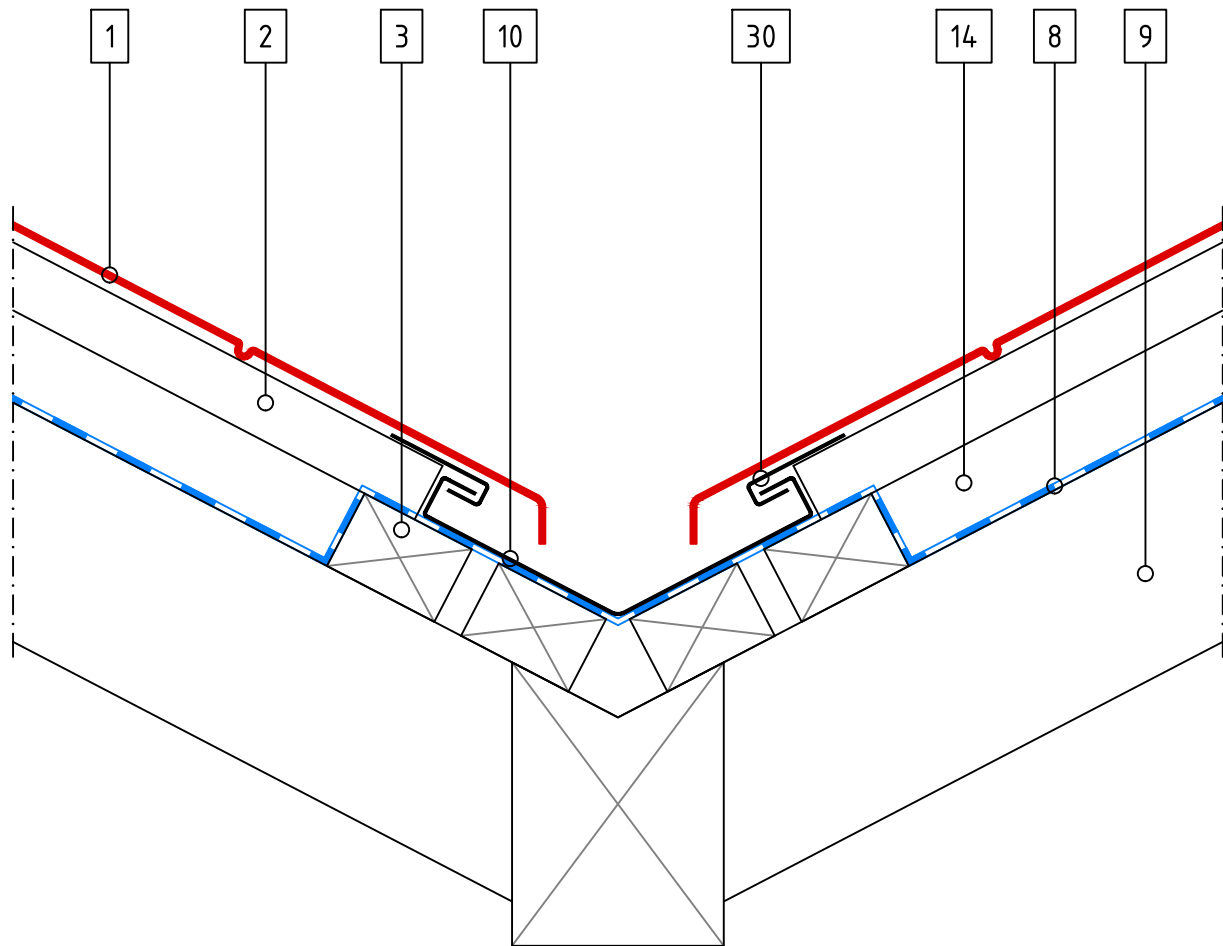

SCALE 1:5

- 1 Tile
- 2 Tile Batten
- 3 Ventilation Space Batten
- 8 Underlay
- 9 Rafter
- 10 Valley
- 14 Ventilation Space
- 30 Clip



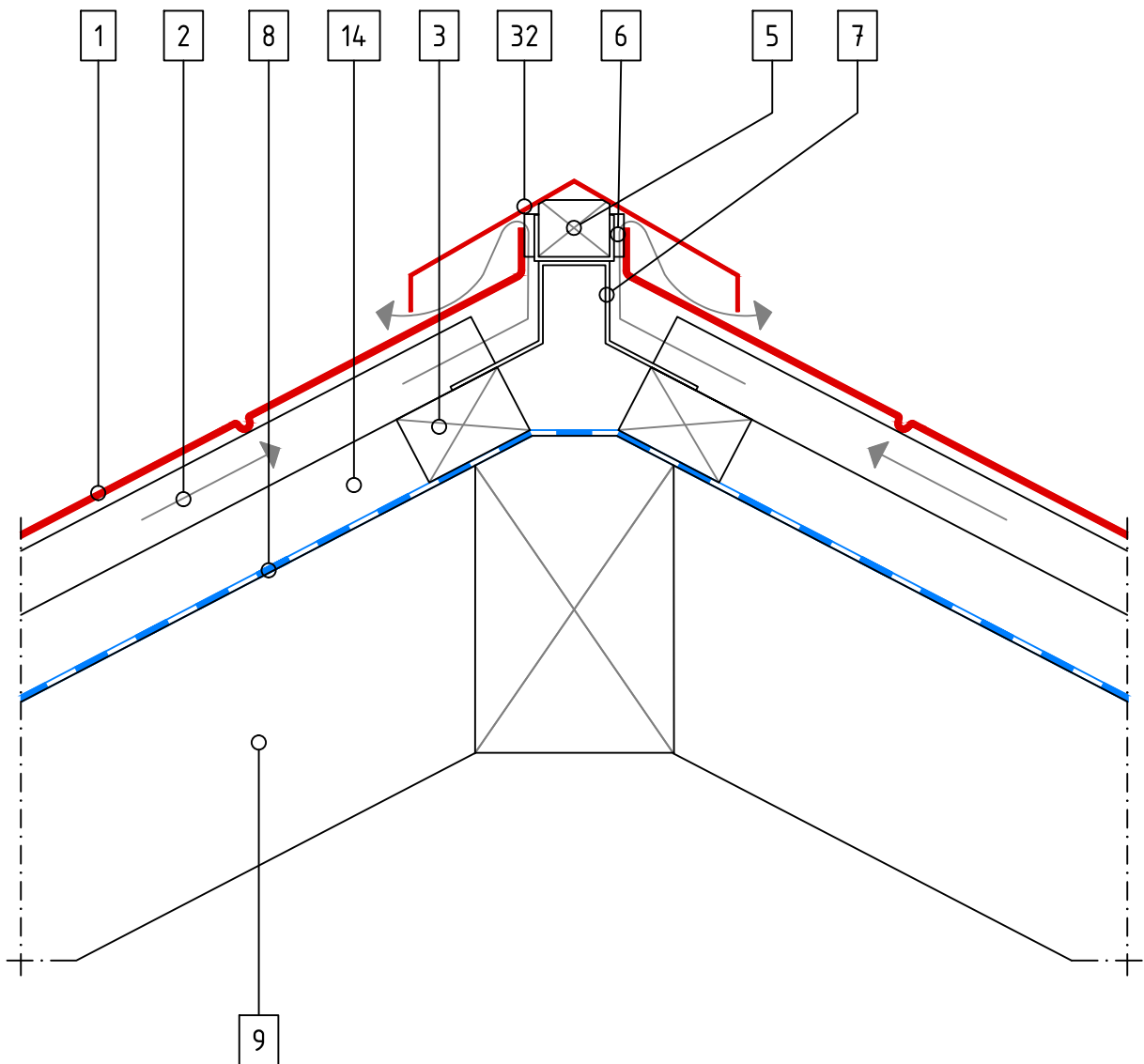

SCALE 1:5

- 1 Tile
- 2 Tile Batten
- 3 Ventilation Space Batten
- 5 Hip Batten
- 6 Spacer
- 7 Hip Bracket
- 8 Underlay
- 9 Rafter
- 14 Ventilation Space
- 32 Ridge Cover 130

# ELEGANTA TILE – Chimney Flashing 1

GERARD

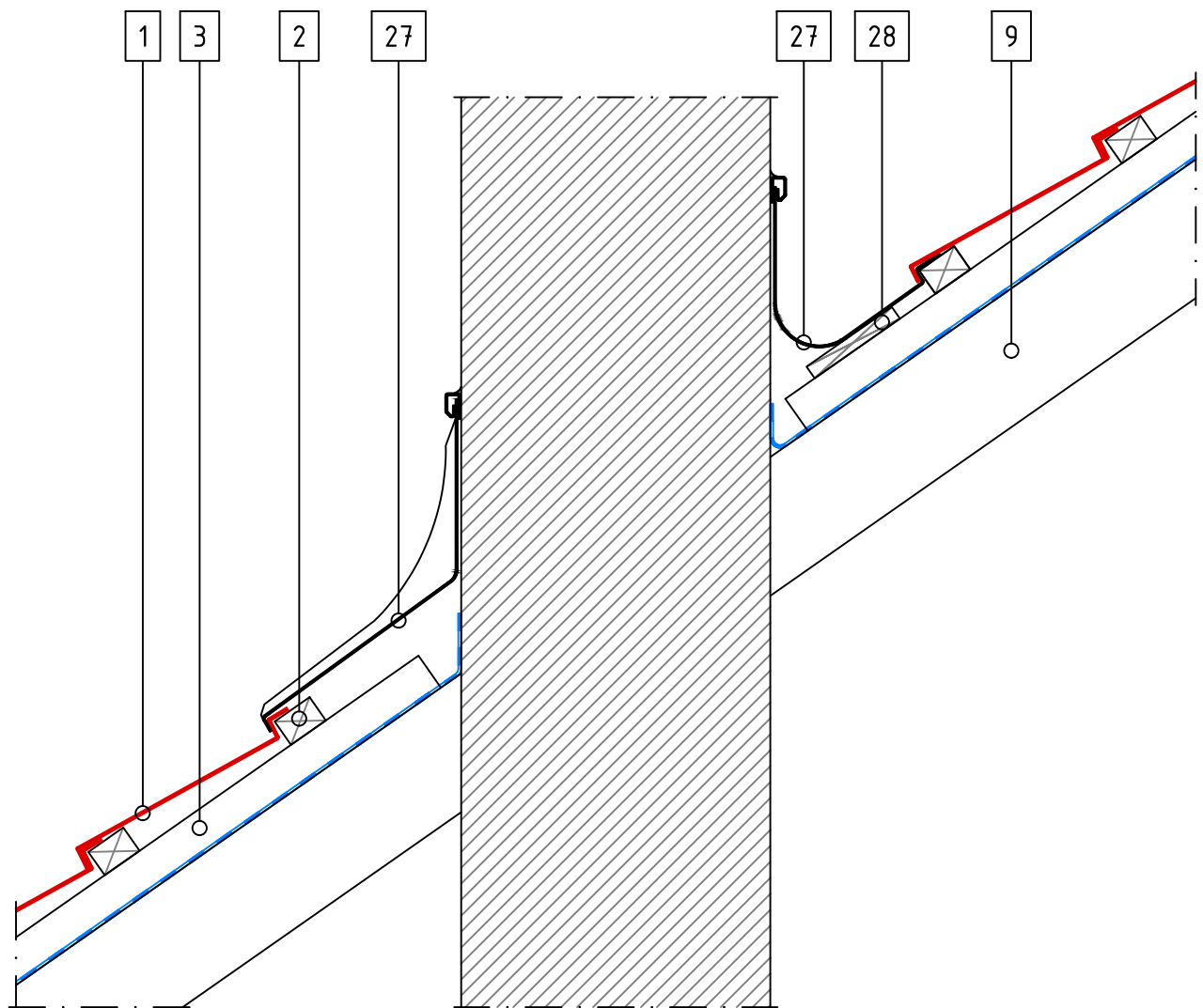

SCALE 1:10

- 1 Tile
- 2 Tile Batten
- 3 Ventilation Space Batten
- 9 Rafter
- 27 Chimney Flashing
- 28 Board

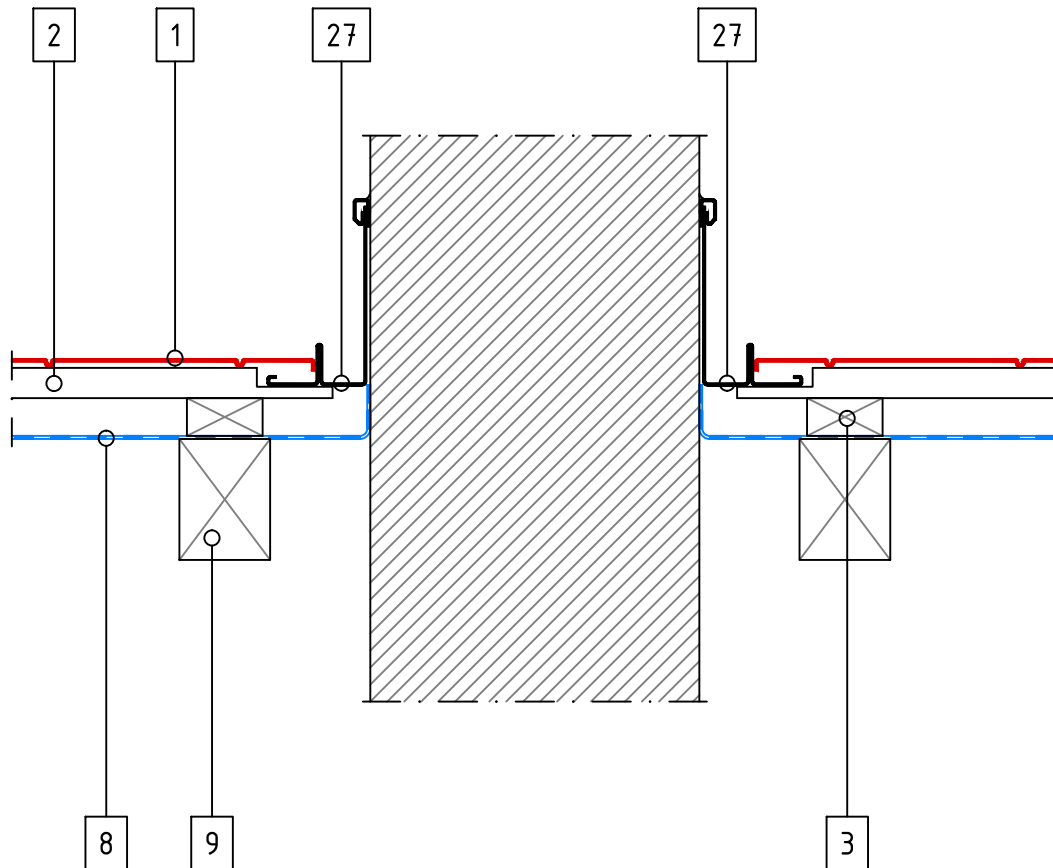

SCALE 1:10

- 1 Tile
- 2 Tile Batten
- 3 Ventilation Space Batten
- 8 Underlay
- 9 Rafter
- 27 Chimney Flashing

# ELEGANTA TILE – Top Wall Flashing 1

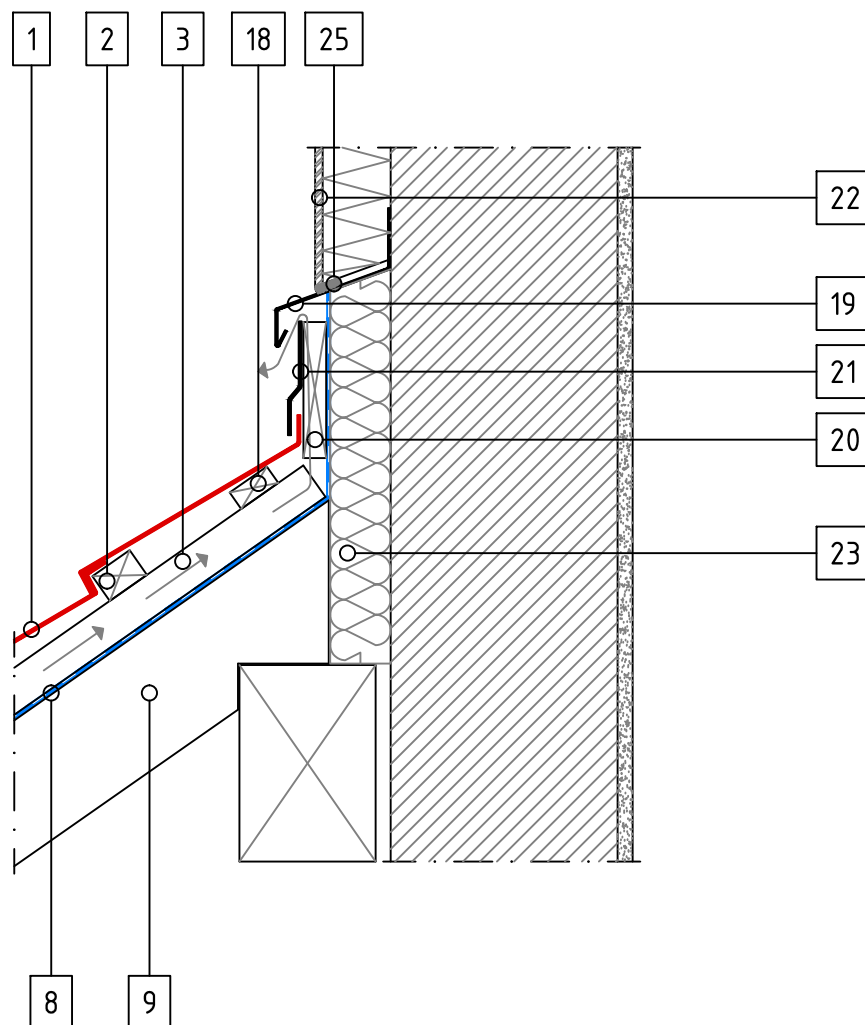

SCALE 1:10

- 1 Tile
- 2 Tile Batten
- 3 Ventilation Space Batten
- 8 Underlay
- 9 Rafter
- 18 Support Batten
- 19 Top Wall Starter Flashing
- 20 Top Wall Spacer
- 21 Side Flashing
- 22 Render
- 23 Warmth Insulation
- 25 Sealant

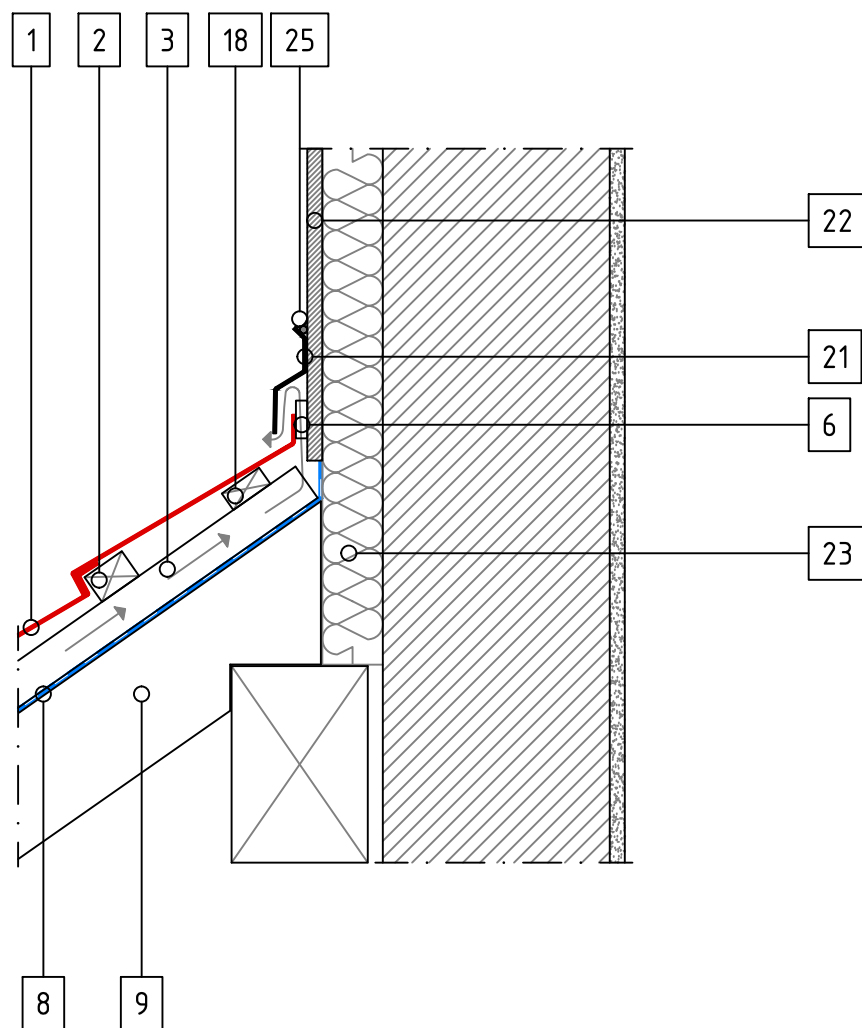

SCALE 1:10

- 1 Tile
- 2 Tile Batten
- 3 Ventilation Space Batten
- 6 Spacer
- 8 Underlay
- 9 Rafter
- 18 Thinner Support Batten
- 21 Side Flashing
- 22 Render
- 23 Warmth Insulation
- 25 Sealant

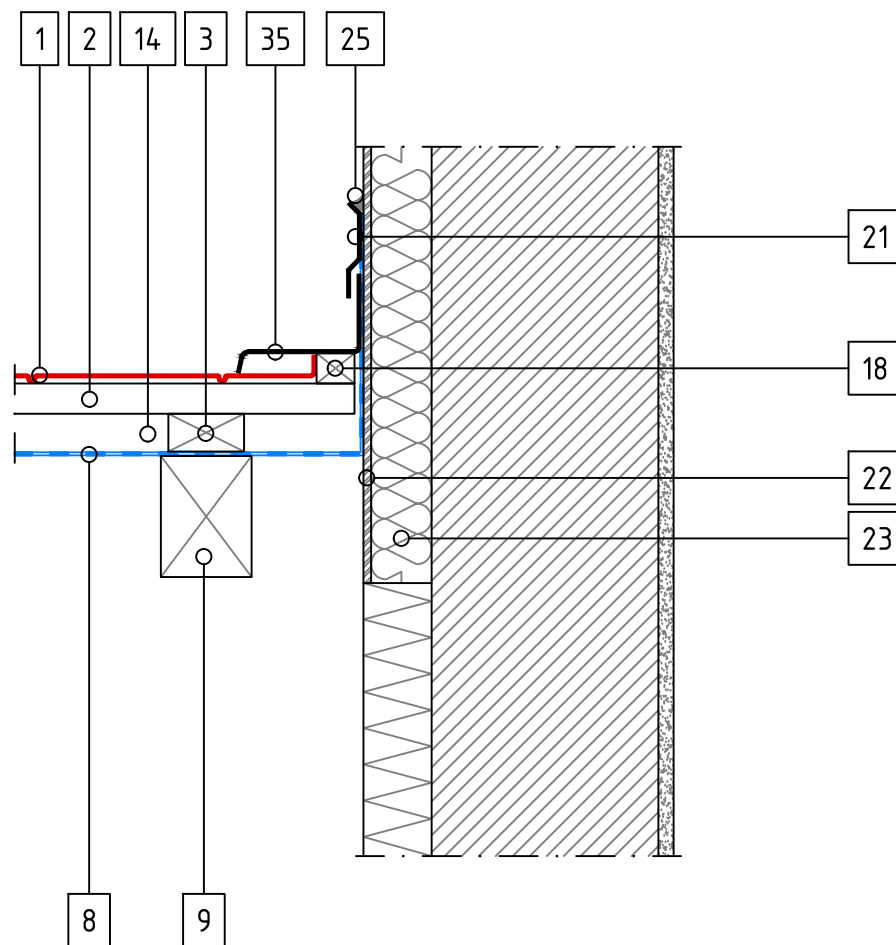

SCALE 1:10

- 1 Tile
- 2 Tile Batten
- 3 Ventilation Space Batten
- 8 Underlay
- 9 Rafter
- 14 Ventilation Space
- 18 Support Batten
- 21 Side Flashing
- 22 Render
- 23 Warmth Insulation
- 25 Sealant
- 35 Scribed Side Wall Flashing

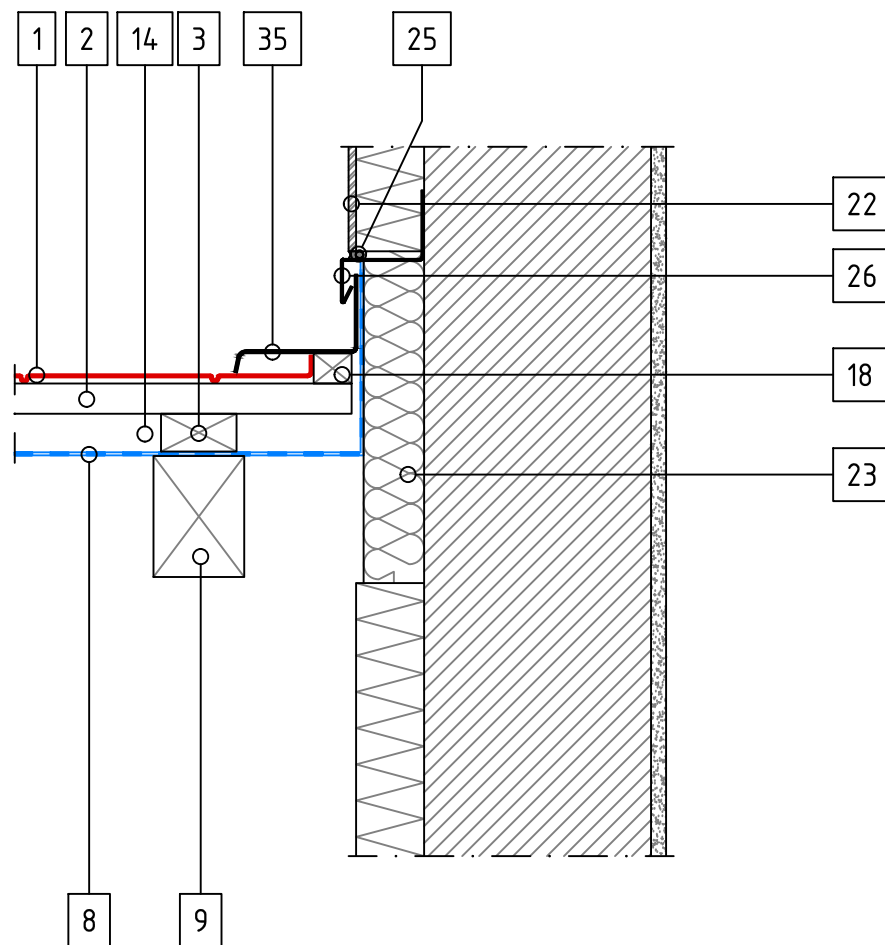

SCALE 1:10

- 1 Tile
- 2 Tile Batten
- 3 Ventilation Space Batten
- 8 Underlay
- 9 Rafter
- 14 Ventilation Space
- 18 Support Batten
- 22 Render
- 23 Warmth Insulation
- 25 Sealant
- 26 Side Wall Starter Flashing
- 35 Scribed Side Wall Flashing